

Type 90 Ti Rotor



**Used In Beckman Coulter
Class H, R, and S
Preparative Ultracentrifuges**



SAFETY NOTICE

This safety notice summarizes information basic to the safe use of the rotor described in this manual. The international symbol displayed above is a reminder to the user that all safety instructions should be read and understood before operation or maintenance of this equipment is attempted. When you see the symbol on other pages throughout this publication, pay special attention to the specific safety information presented. Observance of safety precautions will also help to avoid actions that could damage or adversely affect the performance of the rotor. This rotor was developed, manufactured, and tested for safety and reliability as part of a Beckman Coulter ultracentrifuge/rotor system. Its safety or reliability cannot be assured if used in a centrifuge not of Beckman Coulter's manufacture or in a Beckman Coulter ultracentrifuge that has been modified without Beckman Coulter's approval.



Handle body fluids with care because they can transmit disease. No known test offers complete assurance that such fluids are free of micro-organisms. Some of the most virulent—Hepatitis (B and C) viruses, HIV (I–V), atypical mycobacteria, and certain systemic fungi—further emphasize the need for aerosol protection. Handle other infectious samples according to good laboratory procedures and methods to prevent spread of disease. Because spills may generate aerosols, observe proper safety precautions for aerosol containment. Do not run toxic, pathogenic, or radioactive materials in this centrifuge without taking appropriate safety precautions. Biosafe containment should be used when Risk Group II materials (as identified in the World Health Organization *Laboratory Biosafety Manual*) are handled; materials of a higher group require more than one level of protection.



The rotor and accessories are not designed for use with materials capable of developing flammable or explosive vapors. Do not centrifuge such materials in nor handle or store them near the ultracentrifuge.



Although rotor components and accessories made by other manufacturers may fit in the Type 90 Ti rotor, their safety in this rotor cannot be ascertained by Beckman Coulter. Use of other manufacturers' components or accessories in the Type 90 Ti rotor may void the rotor warranty and should be prohibited by your laboratory safety officer. Only the components and accessories listed in this publication should be used in this rotor.



Make sure that filled containers are loaded symmetrically into the rotor and that opposing tubes are filled to the same level with liquid of the same density. Make sure that cavities in use have the proper spacers inserted (if applicable) before installing the rotor lid.



If disassembly reveals evidence of leakage, you should assume that some fluid escaped the rotor. Apply appropriate decontamination procedures to the centrifuge and accessories.



Never exceed the maximum rated speed of the rotor and labware in use. Refer to the section on RUN SPEEDS, and derate the run speed as appropriate.



Do not use sharp tools on the rotor that could cause scratches in the rotor surface. Corrosion begins in scratches and may open fissures in the rotor with continued use.

TYPE 90 Ti ROTOR

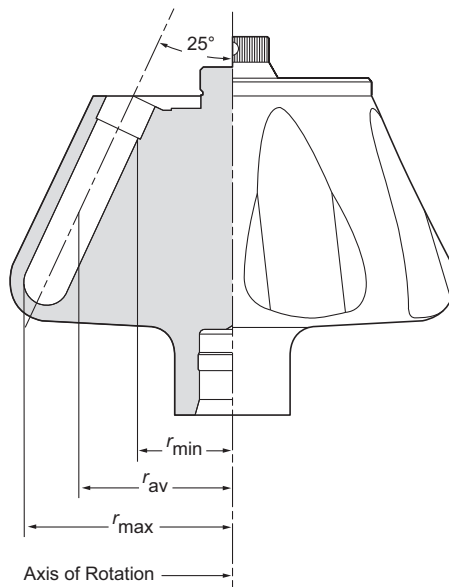

SPECIFICATIONS

Maximum speed	90 000 rpm
Density rating at maximum speed	1.2 g/mL
Relative Centrifugal Field* at maximum speed	
At r_{max} (76.5 mm)	694 000 × g
At r_{av} (55.4 mm)	503 000 × g
At r_{min} (34.2 mm)	310 000 × g
k factor at maximum speed	25
Conditions requiring speed reductions	see RUN SPEEDS
Number of tube cavities	8
Available tubes	see Table 1
Nominal tube dimensions (largest tube)	16 × 76 mm
Nominal tube capacity (largest tube)	13.5 mL
Nominal rotor capacity	108 mL
Approximate acceleration time to maximum speed	
(fully loaded)	6 min
Approximate deceleration time from maximum speed	
(fully loaded)	4 1/2 min
Weight of fully loaded rotor	5 kg (11 lb)
Rotor material	titanium
Lid material	aluminum

* Relative Centrifugal Field (RCF) is the ratio of the centrifugal acceleration at a specified radius and speed ($r\omega^2$) to the standard acceleration of gravity (g) according to the following formula:

$$RCF = \frac{r\omega^2}{g}$$

where r is the radius in millimeters, ω is the angular velocity in radians per second ($2\pi \text{RPM}/60$), and g is the standard acceleration of gravity (9807 mm/s^2). After substitution:

$$RCF = 1.12 r \left(\frac{\text{RPM}}{1000} \right)^2$$

DESCRIPTION

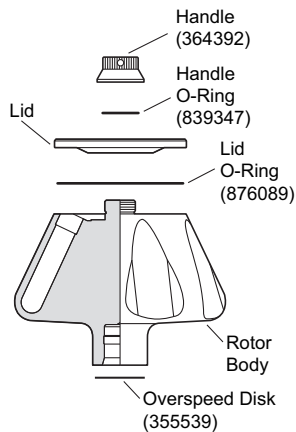

This rotor has been manufactured in a registered ISO 9001 or 13485 facility for use with the appropriately classified Beckman Coulter ultracentrifuges.

The Type 90 Ti, rated for 90 000 rpm, is a fixed angle rotor designed to centrifuge up to eight tubes at a 25-degree angle to the axis of rotation. Used in Beckman Coulter class H, R, and S preparative ultracentrifuges, the rotor develops centrifugal forces sufficient for the differential separation of particles, and for equilibrium sedimentation of particles such as DNA and viruses. Up to 108 mL of gradient and sample volume can be centrifuged per run.

The rotor is made of titanium and is finished with black polyurethane paint. The aluminum lid and handle are anodized for corrosion resistance. O-rings made of Buna N rubber in the lid and handle maintain atmospheric pressure inside the rotor during centrifugation, if they are properly lubricated. Because of the weight of the rotor, drive pins are not required in the rotor drive hub cavity.

For overspeed protection, a photoelectrical detector in the ultracentrifuge monitors the overspeed disk on the rotor bottom and shuts down the run if speeds exceeding 90 000 rpm are detected.

See the Warranty at the back of this manual for warranty information.

PREPARATION AND USE

Specific information about the Type 90 Ti rotor is given here. Information common to this and other rotors is contained in Rotors and Tubes for Preparative Ultracentrifuges (publication LR-IM), which should be used together with this manual for complete rotor and accessory operation.

NOTE

Although rotor components and accessories made by other manufacturers may fit in the Type 90 Ti rotor, their safety in this rotor cannot be ascertained by Beckman Coulter. Use of other manufacturers' components or accessories in the Type 90 Ti rotor may void the rotor warranty and should be prohibited by your laboratory safety officer. Only the components and accessories listed in this publication should be used in this rotor.

PRERUN SAFETY CHECKS

Read the Safety Notice page at the front of this manual before using the rotor.



1. Make sure that the rotor and lid are clean and show no signs of corrosion or cracking.
2. Make sure that the 20-sector (90 000 rpm) overspeed disk is properly attached to the rotor bottom. If it is missing or damaged, replace it according to the instructions in *Rotors and Tubes*.
3. Check the chemical compatibilities of all materials used (refer to Appendix A in *Rotors and Tubes*).
4. Verify that the tubes and bottles being used are listed in Table 1.

ROTOR PREPARATION

For runs at other than room temperature, refrigerate or warm the rotor beforehand for fast equilibration.

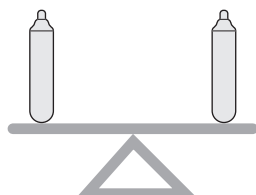

1. Be sure that metal threads in the rotor are clean and lightly but evenly lubricated with Spinkote lubricant (306812). Also ensure that O-rings are lightly but evenly coated with silicone vacuum grease (335148).
2. Load the filled containers symmetrically into the rotor. (Refer to TUBES AND BOTTLES on page 7 for information about containers.) If fewer than eight tubes are being run, they must be arranged symmetrically in the rotor (see Figure 1). Opposing tubes must be filled to the same level with liquid of the same density.
3. Complete loading by placing the correct spacers (if required) over the tubes.

NOTE

Place filled tubes in at least two opposing cavities. Make sure that cavities in use have the proper spacers inserted (if applicable) before installing the rotor lid.

4. Put the lid in place and tighten by hand as firmly as possible.

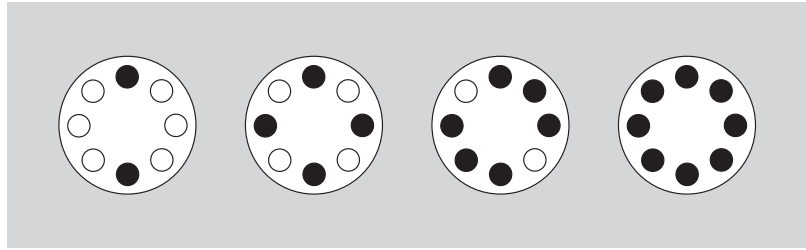

Figure 1. Arranging Tubes in the Rotor. Two, four, six, or eight tubes can be centrifuged per run, if they are arranged in the rotor as shown.

OPERATION

1. Carefully lower the rotor straight down onto the drive hub.
2. Refer to the applicable instrument instruction manual for ultracentrifuge operation.
3. For additional operating information, see the following:
 - RUN TIMES, page 12, for using k factors to adjust run durations
 - RUN SPEEDS, page 13, for information about speed limitations
 - SELECTING CsCl GRADIENTS, page 15, for methods to avoid CsCl precipitation during centrifugation

REMOVAL AND SAMPLE RECOVERY



CAUTION

If disassembly reveals evidence of leakage, you should assume that some fluid escaped the rotor. Apply appropriate decontamination procedures to the ultracentrifuge and accessories.

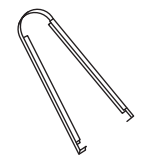

Quick-Seal Tube
Removal Tool
(361668)

1. Remove the rotor by lifting it straight up and off the drive hub.
2. Remove the rotor lid.
3. Use the appropriate removal tool (listed in the SUPPLY LIST) to remove the spacers and tubes.

TUBES AND BOTTLES

The Type 90 Ti rotor uses the tubes and bottles listed in Table 1. Be sure to use only those items listed, and to observe the maximum speed limits and fill volumes shown. (Maximum fill volume is the maximum amount that can be centrifuged in the container listed.) Refer to Appendix A in *Rotors and Tubes* for chemical compatibilities of tube, bottle, and accessory materials.

Table 1. Available Tubes for the Type 90 Ti Rotor. Use only the items listed here.

Tube			Required Accessory		Tube Rack	Max Speed/ RCF/ k Factor
Dimensions and Volume	Description	Part Number	Description	Part Number		
16 × 76 mm 13.5 mL	Quick-Seal Ultra-Clear	344322 (pkg/50)	red aluminum spacer	342695	348123 ^a	90 000 rpm 694 000 × g 25
16 × 76 mm 13.5 mL	Quick-Seal polypropylene	342413 (pkg/50)	red aluminum spacer	342695	348123 ^a	90 000 rpm 694 000 × g 25
16 × 76 mm 13.5 mL	Ultra-Clear	344085 (pkg/50)	titanium cap (use the red silicone O-ring)	341968	none	80 000 rpm 548 000 × g 32
16 × 76 mm 13.5 mL	thinwall polypropylene	326814 (pkg/50)	titanium cap (use the black Buna N O-ring)	341968	none	80 000 rpm 548 000 × g 32
16 × 76 mm 10 mL	thickwall polypropylene	355640 (pkg/25)	aluminum cap	338907	none	30 000 rpm 77 000 × g 190

^a Tube Topper rack; if using the older tabletop tube sealer, use tube rack 342488.

— continued

^b Max speeds given are those that the tubes could withstand when tested at 25°C for 24 hours. Further tests have shown that the polycarbonate tubes can run at 75 000 rpm for 6 hours or at 65 000 rpm for 8 hours.

^c For solution densities of 2.0 g/mL and below; above 2.0, further speed reductions are required. Refer to publication L5-TB-072 before centrifuging stainless steel tubes.

^d Noryl is a registered trademark of GE Plastics.

^e For lower fill volumes (not less than 5 mL) centrifuge no faster than 60 000 rpm.

^f Tube Topper rack, if using the older tabletop tube sealer, use rack 344641.

^g Includes disposable plastic plugs.

^h Ultem is a registered trademark of GE Plastics.

ⁱ Delrin is a registered trademark of E.I. Du Pont de Nemours & Company.

^j Cap assembly includes neoprene gasket (344672) and stem (346246).

^k Tube Topper rack; if using the older tabletop tube sealer, use rack 344641 and use spacer (345828) upside-down in the bottom of the tube rack before inserting a tube (to remove the spacers, turn the rack upside-down).

Table 1. Available Tubes for the Type 90 Ti Rotor (continued)

Tube			Required Accessory		Tube Rack	Max Speed/ RCF/ k Factor
Dimensions and Volume	Description	Part Number	Description	Part Number		
16 × 76 mm 10 mL	thickwall polycarbonate	355630 (pkg/25)	aluminum cap	338907	none	50 000 rpm ^b 197 000 × g 69
16 × 76 mm 10.4 mL	polycarbonate bottle assembly (bottle only—355651)	355603 (pkg/6)	Noryl ^d cap	355604	none	65 000 rpm ^e 362 000 × g 48
16 × 67 mm 10 mL	Quick-Seal polypropylene	344622 (pkg/50)	Noryl spacer	344676	348123 ^f	90 000 rpm 694 000 × g 21
16 × 60 mm 8.9 mL	OptiSeal bell-top ^g	361623 (pkg/56)	amber Ultem ^h spacer	361670 (pkg/2)	361642	90 000 rpm 694 000 × g 21
13 × 64 mm 6.5 mL	Ultra-Clear	344088 (pkg/50)	Delrin ⁱ adapter	303313	none	50 000 rpm 197 000 × g 69
			aluminum cap	346256 ^j		
16 × 64 mm 6.5 mL	thinwall polypropylene	326820 (pkg/50)	Delrin adapter	303313	none	50 000 rpm 197 000 × g 69
			aluminum cap	346256 ^j		
16 × 64 mm 6.5 mL	stainless steel	301099	Delrin adapter	303313	none	40 000 rpm ^c 126 000 × g 108
			aluminum cap	303319		
16 × 45 mm 6.3 mL	Quick-Seal polypropylene	345830 (pkg/50)	Noryl floating spacer	345828	348123 ^k	90 000 rpm 694 000 × g 14

^a Tube Topper rack; if using the older tabletop tube sealer, use tube rack 342488.

— continued

^b Max speeds given are those that the tubes could withstand when tested at 25°C for 24 hours. Further tests have shown that the polycarbonate tubes can run at 75 000 rpm for 6 hours or at 65 000 rpm for 8 hours.

^c For solution densities of 2.0 g/mL and below; above 2.0, further speed reductions are required. Refer to publication L5-TB-072 before centrifuging stainless steel tubes.

^d Noryl is a registered trademark of GE Plastics.

^e For lower fill volumes (not less than 5 mL) centrifuge no faster than 60 000 rpm.

^f Tube Topper rack, if using the older tabletop tube sealer, use rack 344641.

^g Includes disposable plastic plugs.

^h Ultem is a registered trademark of GE Plastics.

ⁱ Delrin is a registered trademark of E.I. Du Pont de Nemours & Company.

^j Cap assembly includes neoprene gasket (344672) and stem (346246).

^k Tube Topper rack; if using the older tabletop tube sealer, use rack 344641 and use spacer (345828) upside-down in the bottom of the tube rack before inserting a tube (to remove the spacers, turn the rack upside-down).

Table 1. Available Tubes for the Type 90 Ti Rotor (continued)

Tube			Required Accessory		Tube Rack	Max Speed/ RCF/ k Factor
Dimensions and Volume	Description	Part Number	Description	Part Number		
16 × 45 mm 6.3 mL	Quick-Seal polypropylene	357334 (pkg/50)	Noryl floating spacer	345828	348123 ^k	90 000 rpm 694 000 × g 14
16 × 38 mm 4.2 mL	Quick-Seal polypropylene	356562 (pkg/50)	Noryl floating spacer	345828	348123 ^a	90 000 rpm 694 000 × g 11
16 × 38 mm 4.2 mL	Quick-Seal polypropylene	357332 (pkg/50)	Noryl floating spacer	345828	348123 ^a	90 000 rpm 694 000 × g 11
13 × 64 mm 4 mL	thickwall polypropylene	355644 (pkg/25)	Delrin adapter	303313	none	50 000 rpm 197 000 × g 69
13 × 64 mm 4 mL	thickwall polycarbonate	355645 (pkg/25)	Delrin adapter	303313	none	50 000 rpm ^b 197 000 × g 69
13 × 41 mm 4 mL	Ultra-Clear	344093 (pkg/50)	Delrin adapter	303402	none	45 000 rpm 138 000 × g 67
			aluminum cap	346256 ^j		
13 × 32 mm 3 mL	Ultra-Clear	344092 (pkg/50)	Delrin adapter	303401	none	45 000 rpm 129 000 × g 59
			aluminum cap	346256 ^j		
8 × 49 mm 2 mL	Ultra-Clear	344091 (pkg/50)	Delrin adapter	303376	none	40 000 rpm 128 000 × g 72
			aluminum cap	303624		

^a Tube Topper rack; if using the older tabletop tube sealer, use tube rack 342488.

^b Max speeds given are those that the tubes could withstand when tested at 25°C for 24 hours. Further tests have shown that the polycarbonate tubes can run at 75 000 rpm for 6 hours or at 65 000 rpm for 8 hours.

^c For solution densities of 2.0 g/mL and below; above 2.0, further speed reductions are required. Refer to publication L5-TB-072 before centrifuging stainless steel tubes.

^d Noryl is a registered trademark of GE Plastics.

^e For lower fill volumes (not less than 5 mL) centrifuge no faster than 60 000 rpm.

^f Tube Topper rack, if using the older tabletop tube sealer, use rack 344641.

^g Includes disposable plastic plugs.

^h Ultem is a registered trademark of GE Plastics.

ⁱ Delrin is a registered trademark of E.I. Du Pont de Nemours & Company.

^j Cap assembly includes neoprene gasket (344672) and stem (346246).

^k Tube Topper rack; if using the older tabletop tube sealer, use rack 344641 and use spacer (345828) upside-down in the bottom of the tube rack before inserting a tube (to remove the spacers, turn the rack upside-down).

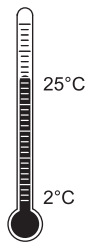

Temperature Limits

- Plastic tubes and bottles have been centrifuge tested for use at temperatures between 2 and 25°C. For centrifugation at other temperatures, pretest tubes under anticipated run conditions.
- If plastic containers are frozen before use, make sure that they are thawed to at least 2°C prior to centrifugation.

OptiSeal Tubes

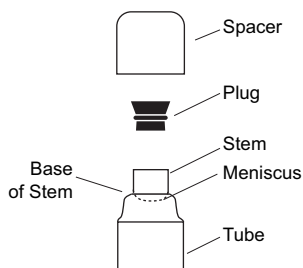

OptiSeal tubes come with plastic plugs and can be quickly and easily prepared for use. With the tube spacer in place, the *g* force during centrifugation ensures a tight, reliable seal that protects your samples.

- Place the tubes in the rack and fill each tube to the base of the stem, leaving no fluid in the stem. Overfilling the tube can cause spillage when the plug is inserted or can compromise seal integrity. However, too much air can cause excessive tube deformation, disrupting gradients and sample bands.
- Refer to *Using OptiSeal Tubes* (publication IN-189), included in each box of tubes, for detailed information on the use and care of OptiSeal tubes.

Quick-Seal Tubes

Quick-Seal tubes must be sealed prior to centrifugation. These tubes are heat sealed and do not need caps; however, spacers are required on top of the tubes when they are loaded into the rotor.



- Fill Quick-Seal tubes leaving a *small* bubble of air at the base of the neck. Do not leave a large air space—too much air can cause excessive tube deformation.
- Refer to *Rotors and Tubes* for detailed information on the use and care of Quick-Seal tubes.



Thinwall Tubes

Thinwall polypropylene and Ultra-Clear tubes require caps for tube support. Fill the tubes as full as possible to prevent tube collapse during centrifugation. If necessary, float mineral oil (or some other low-density, immiscible liquid) on top of the tube contents to fill the tube to its maximum volume. (Do not use an oil overlay in Ultra-Clear tubes.)



Thickwall Tubes

Thickwall polypropylene and polycarbonate tubes can be run partially filled (at least half filled) with or without caps, but all opposing tubes for a run must be filled to the same level with liquid of the same density. Do not overfill capless tubes; be sure to note the reductions in fill volume and run speed shown in Table 1.



Stainless Steel Tubes

These tubes can be filled to any level, but all opposing tubes for a run must be filled to the same level. Read the section on RUN SPEEDS before centrifuging stainless steel tubes.

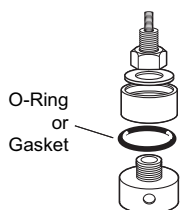

Tube Caps

Thinwall tubes require caps for tube support during centrifugation; thickwall tubes and bottles can be run with or without caps (speed reduction may be required). Use only the caps listed in Table 1. Refer to *Rotors and Tubes* for the use, assembly, and maintenance of caps.

- Inspect tube caps before use as described in *Rotors and Tubes*. Replace any damaged components.
- Inspect the O-rings or gaskets in the caps for cracks, nicks, or flattened areas. Be sure that they are dry and free of lubricant during assembly.
- Tighten caps with a torque wrench to 11 N•M (100 in.-lb) while the tube is held in the tube-cap vise (305075).
- Tighten bottle caps by hand.

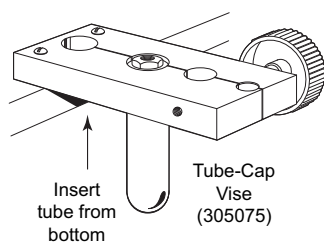



Polycarbonat Bottles

The polycarbonat bottles may be centrifuged completely filled, or partially filled (not less than half full). Again, all opposing containers for a run must be filled to the same level. Be sure to note the reductions in run speed shown in Table 1 if bottles are partially filled.

RUN TIMES

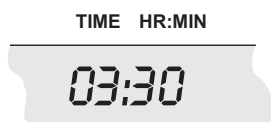

The k factor of the rotor is a measure of the rotor's pelleting efficiency. (Beckman Coulter has calculated the k factors for all of its preparative rotors at maximum rated speed and using full tubes.) The k factor is calculated from the formula:

$$k = \frac{\ln(r_{\max}/r_{\min})}{\omega^2} \times \frac{10^{13}}{3600} \quad (1)$$

where ω is the angular velocity of the rotor in radians per second ($\omega = 0.105 \times \text{rpm}$), r_{\max} is the maximum radius, and r_{\min} is the minimum radius.

After substitution:

$$k = \frac{(2.533 \times 10^{11}) \ln(r_{\max}/r_{\min})}{\text{rpm}^2} \quad (2)$$

Use the k factor in the following equation to estimate the run time t (in hours) required to pellet particles of known sedimentation coefficient s (in Svedberg units, S).

$$t = \frac{k}{s} \quad (3)$$

Run times can be estimated for centrifugation at less than maximum speed by adjusting the k factor as follows:

$$k_{\text{adj}} = k \left(\frac{90\,000}{\text{actual run speed}} \right)^2 \quad (4)$$

Run times can also be estimated from data established in prior experiments using a different rotor if the k factor of the previous rotor is known. For any two rotors, a and b:

$$\frac{t_a}{t_b} = \frac{k_a}{k_b} \quad (5)$$

For more information on k factors see *Use of k Factor for Estimating Run Times from Previously Established Run Conditions* (publication DS-719).

RUN SPEEDS



The centrifugal force at a given radius in a rotor is a function of speed. Comparisons of forces between different rotors are made by comparing the rotors' relative centrifugal fields (RCF). When rotational speed is adjusted so that identical samples are subjected to the same RCF in two different rotors, the samples are subjected to the same force. The RCF at a number of rotor speeds is provided in Table 2.

Do not select rotational speeds that exceed the limits in Table 1. In addition, speeds must be reduced under the following circumstances:

1. If nonprecipitating solutions more dense than 1.2 g/mL are centrifuged *in plastic tubes or bottles*, the maximum allowable run speed must be reduced according to the following equation:

$$\text{reduced maximum speed} = (90\,000 \text{ rpm}) \sqrt{\frac{1.2 \text{ g/mL}}{\rho}} \quad (6)$$

where ρ is the density of tube contents. This speed reduction will protect the rotor from excessive stresses due to the added tube load. *Note, however, that the use of this formula may still produce maximum speeds that are higher than the limitations imposed by the use of certain tubes or adapters (see Table 1).* In such cases, use the lower of the two speeds.

Table 2. Relative Centrifugal Fields for the Type 90 Ti Rotor.
 Entries in this table are calculated from the formula
 $RCF = 1.12 r (RPM/100)^2$
 and then rounded to three significant digits.

Rotor Speed (rpm)	Relative Centrifugal Field ($\times g$)			k Factor*
	At r_{max} (76.5 mm)	At r_{av} (55.4 mm)	At r_{min} (34.2 mm)	
90 000	694 000	503 000	310 000	25
85 000	619 000	448 000	277 000	28
80 000	548 000	397 000	245 000	32
75 000	482 000	349 000	215 000	36
70 000	420 000	304 000	188 000	42
65 000	362 000	262 000	162 000	48
60 000	308 000	223 000	138 000	57
55 000	259 000	188 000	116 000	67
50 000	214 000	155 000	95 800	82
45 000	174 000	126 000	77 600	101
40 000	137 000	99 300	61 300	127
35 000	105 000	76 000	46 900	166
30 000	77 100	55 800	34 500	227

* Calculated for all Beckman Coulter preparative rotors as a measure of the rotor's pelleting efficiency in water at 20°C.

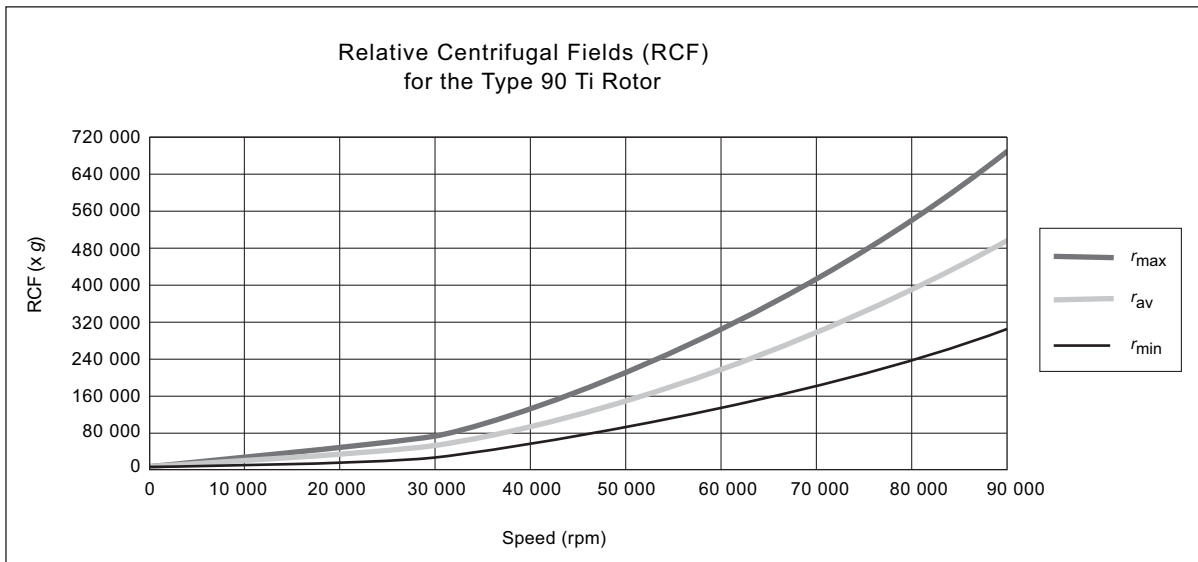

2. For centrifuging solutions of any density in *stainless steel tubes and aluminum cap combinations*, use the following formula to determine the allowable rotor speed based on the tube load:

$$\text{reduced maximum speed} = (90\,000 \text{ rpm}) \sqrt{\frac{46.2 \text{ grams}}{X}} \quad (7)$$

where X = the weight in grams of the capped tube plus the liquid contents to be centrifuged.

In any case, the rotor speed when using this tube/cap combination must not exceed the limits in Table 1.

3. *Further speed limits must be imposed* when CsCl or other self-forming-gradient salts are centrifuged, as equation (6) or (7) does not predict concentration limits/speeds that are required to avoid precipitation of salt crystals. Solid CsCl has a density of 4 g/mL, and if precipitated during centrifugation may cause catastrophic rotor failure and instrument damage. Figures 2 and 3, together with the description and examples below, show how to reduce run speeds when using CsCl gradients.

SELECTING CsCl GRADIENTS



Precipitation during centrifugation would alter density distribution, and this would change the position of the sample bands. Curves in Figures 2 and 3 are provided up to the maximum rated speed of the rotor, but note also that *tubes or bottles must never be centrifuged faster than the limits in Table 1.*

NOTE

The curves in Figures 2 and 3 are for solutions of CsCl salt dissolved in distilled water only. If other salts are present in significant concentrations, the overall CsCl concentration may need to be reduced.

Rotor speed is used to control the slope of a CsCl density gradient, and must be limited so that CsCl precipitation is avoided. Speed and density combinations that intersect on or below the curves in Figure 2 ensure that CsCl will not precipitate during centrifugation in the Type 90 Ti rotor. Curves are provided at two temperatures: 20°C (gray curves) and 4°C (black curves).

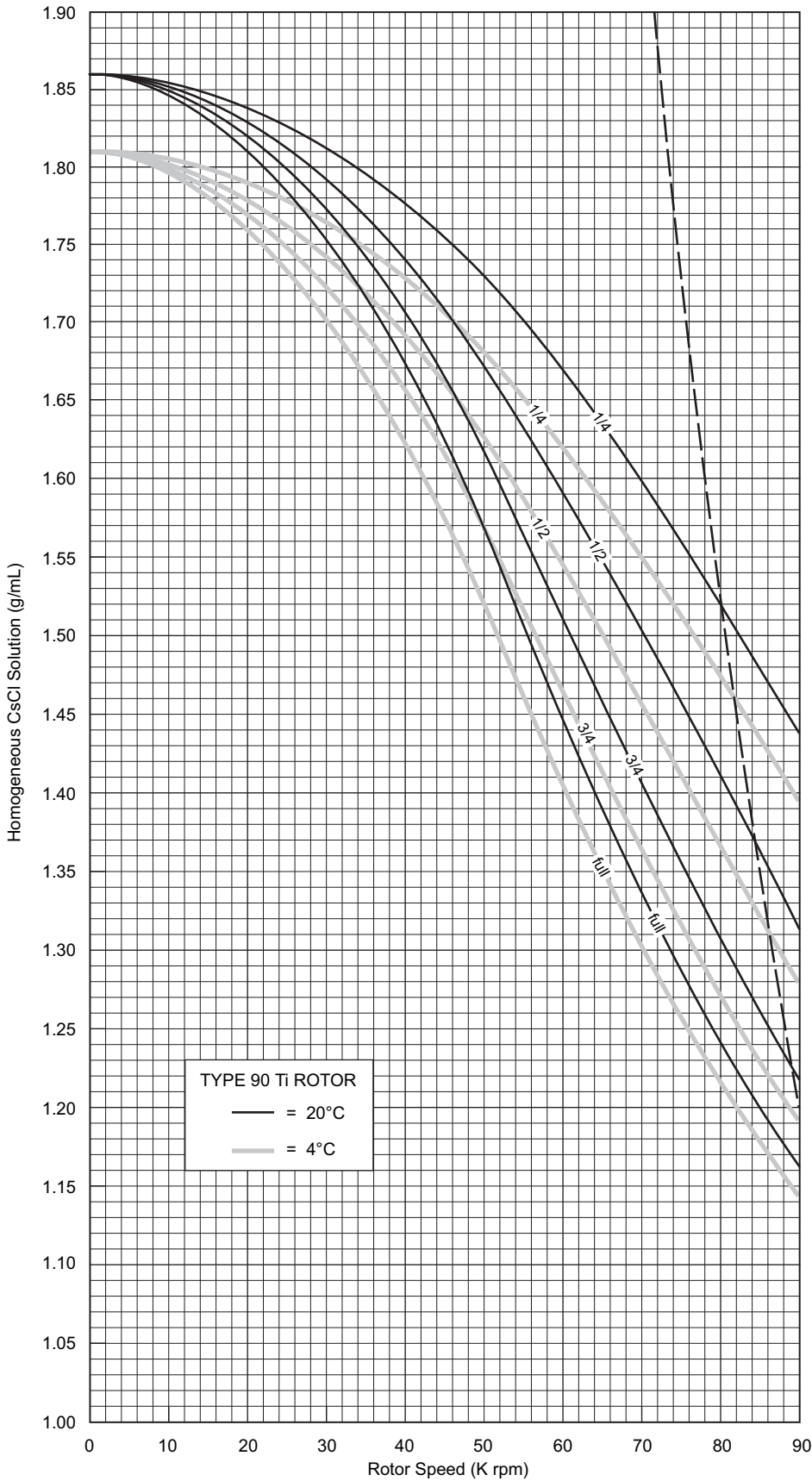

Figure 2. Precipitation Curves. Using combinations of rotor speeds and homogeneous CsCl solution densities that intersect on or below these curves ensures that CsCl will not precipitate during centrifugation. The dashed lines represent equation (6), and are shown here to illustrate the inability of that equation to guard against CsCl precipitation.

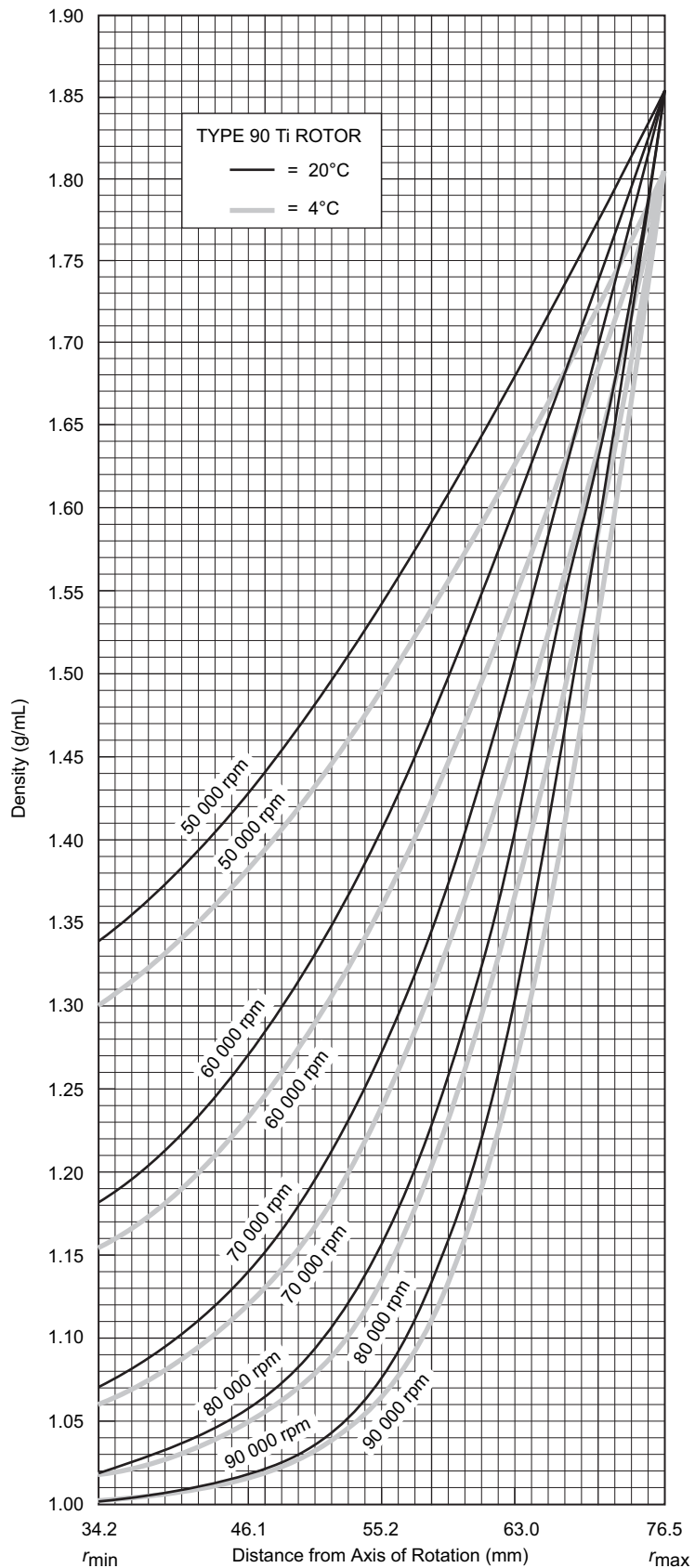
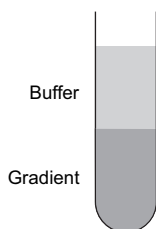

Figure 3. CsCl Gradients at Equilibrium. Centrifugation of homogeneous CsCl solutions at the maximum allowable speeds (from Figure 2) results in gradients presented here.

The reference curves in Figure 3 show gradient distribution at equilibrium. Each curve in Figure 3 is within the density limits allowed for the Type 90 Ti rotor: each curve was generated for a single run speed using the maximum allowable homogeneous CsCl densities (one for each fill level) that avoid precipitation at that speed. (The gradients in Figure 3 can be generated from step or linear gradients, or from homogeneous solutions. But the total amount of CsCl in solution must be equivalent to a homogeneous solution corresponding to the concentrations specified in Figure 2.) Figure 3 can also be used to approximate the banding positions of sample particles.

ADJUSTING FILL VOLUMES



Figures 2 and 3 show that several fill volumes are possible in a tube. If a tube is partially filled with gradient solution, float mineral oil (or some other low-density, immiscible liquid) on top of the tube contents to fill the tube to its maximum volume. (Do not use an oil overlay in Ultra-Clear tubes.) Note that for a given CsCl density, as the fill level decreases the maximum allowable speed increases. Partial filling may be desirable when there is little sample or when you wish to shorten the run time.

For example, a *quarter-filled* tube of 1.52-g/mL homogeneous CsCl solution at 20°C may be centrifuged at 80 000 rpm (see Figure 2). The same solution in a *half-filled* tube may be centrifuged no faster than 68 000 rpm. (Gradient curves not shown in Figure 3 can be interpolated.) A tube *full* of the 1.52-g/mL CsCl solution may be centrifuged no faster than 53 000 rpm.

TYPICAL EXAMPLES FOR DETERMINING CsCl RUN PARAMETERS

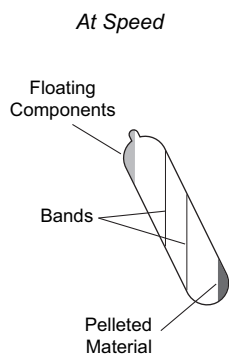

Example A: Knowing homogeneous CsCl solution density (1.55 g/mL) and approximate particle buoyant densities (1.53 and 1.57 g/mL), where will particles band?

1. In Figure 2, find the curve that corresponds to the required run temperature (20°C). The maximum allowable rotor speed is determined from the point where this curve intersects the homogeneous CsCl density (52 000 rpm).
2. In Figure 3, sketch in a horizontal line corresponding to each particle's buoyant density.

At Rest
in Rotor

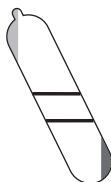

Upright



3. Mark the point in the figure where each particle density intersects the curve corresponding to the selected run speed and temperature.
4. Particles will band at these locations across the tube diameter at equilibrium during centrifugation.

In this example, particles will band about 55.2 and 58.1 mm from the axis of rotation, about 2.9 mm of centerband-to-centerband separation at the rotor's 25-degree tube angle. When the tube is removed from the rotor and held upright (vertical and stationary), there will be about 3.2 mm of centerband-to-centerband separation. This interband distance, d_{up} , can be calculated from the formula:

$$d_{up} = \frac{d_{\theta}}{\cos \theta} \quad (8)$$

where d_{θ} is the interband distance when the tube is held at an angle, θ , in the rotor.

Example B: Knowing particle buoyant densities (1.50 and 1.52 g/mL), how do you achieve good separation?

1. In Figure 3, sketch in a horizontal line corresponding to each particle's buoyant density.
2. Select the curve at the required temperature (4°C) and tube volume (full) that gives the best particle separation.
3. Note the run speed along the selected curve (50 000 rpm).
4. From Figure 2, select the maximum homogeneous CsCl density (in this case, 1.51 g/mL) that corresponds to the temperature and run speed established above. These parameters will provide the particle-banding pattern selected in Step 2.

In this example, particles will band at about 55.9 and 57.6 mm from the axis of rotation (about 1.75 mm apart). When the tube is held upright there will be about 1.92 mm of center-of-band to center-of-band separation.

CARE AND MAINTENANCE

MAINTENANCE

NOTE

Do not use sharp tools on the rotor that could cause scratches in the rotor surface. Corrosion begins in scratches and may open fissures in the rotor with continued use.

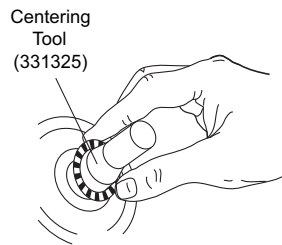
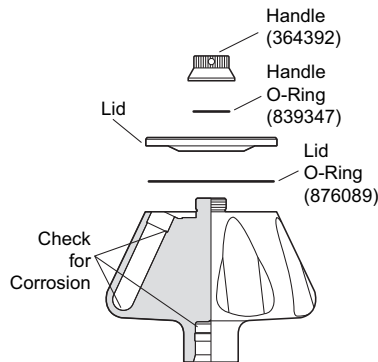

- Periodically (at least monthly) inspect the rotor, especially inside cavities, for rough spots or pitting, white powder deposits (frequently aluminum oxide), or heavy discoloration. If any of these signs are evident, do not run the rotor. Contact your Beckman Coulter representative for information about the Field Rotor Inspection Program and the rotor repair center.
- Regularly lubricate the metal threads in the rotor with a thin, even coat of Spinkote lubricant (306812). Failure to keep these threads lubricated can result in damaged threads.
- Regularly apply silicone vacuum grease (335148) to the O-rings. Replace O-rings about twice a year or whenever worn or damaged.
- Regularly inspect the overspeed disk. If it is scratched, damaged, or missing, replace it according to the instructions in *Rotors and Tubes*.
- Because of the high forces generated in this rotor, it is extremely important to inspect tube caps before use to be sure they are in good condition.
 - a. Inspect the cap crown for deformed or roughened edges.
 - b. Run a finger around the bottom edge of the crown; surfaces should be flat, squared-off, and not rounded or jagged.
 - c. Check the top of the crown and stem for stress cracks or fine, circular lines.
 - d. Look at the underside of the stem; the white nylon insert should not protrude below the filling hole.
 - e. Before each use, check the O-ring for cuts, abrasions, or flattened areas.

Discard and replace any damaged component. Refer to *Rotors and Tubes* for detailed information about tube cap inspection and maintenance.

Refer to the chemical resistances table in Appendix A of *Rotors and Tubes* for chemical compatibilities of rotor and accessory materials. Your Beckman Coulter representative provides contact with the Field Rotor Inspection Program and the rotor repair center.

CLEANING



Wash the rotor and rotor components immediately if salts or other corrosive materials are used or if spillage has occurred. Do not allow corrosive materials to dry on the rotor.

Under normal use, wash the rotor frequently (at least weekly) to prevent buildup of residues.

1. Remove the O-rings before washing.
2. Wash the rotor and lid in a mild detergent, such as Beckman Solution 555 (339555), that won't damage the rotor. The Rotor Cleaning Kit (339558) contains two special plastic-coated brushes and two quarts of Solution 555 for use with rotors and accessories. Dilute the detergent 10 to 1 with water.

NOTE

Do not wash rotor components in a dishwasher.
Do not soak in detergent solution for long periods, such as overnight.

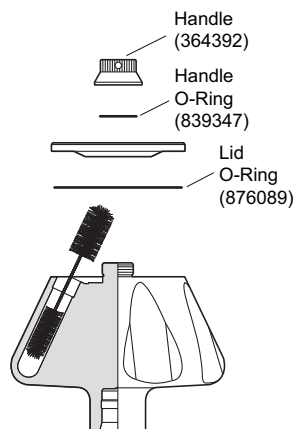

3. Thoroughly rinse the cleaned rotor and components with distilled water.
4. Air-dry the rotor and lid upside down. *Do not use acetone to dry the rotor.*
5. Apply a thin, even coat of silicone vacuum grease to the lid O-ring before replacing it in the groove in the outer rim of the lid. Also apply silicone vacuum grease to the handle O-ring before reassembly.

Clean metal threads every 6 months, or as necessary. Use a brush and concentrated Solution 555. Rinse and dry thoroughly, then lubricate lightly but evenly with Spinkote to coat all threads.

Periodically remove the O-rings and wipe clean as necessary. Clean the O-ring grooves with a cotton-tipped swab. Reapply a light film of silicone vacuum grease.

DECONTAMINATION



If the rotor (and/or accessories) becomes contaminated with radioactive material, it should be decontaminated using a solution that will not damage the anodized surfaces. Beckman Coulter has tested a number of solutions and found two that do not harm anodized aluminum: RadCon Surface Spray or IsoClean Solution (for soaking),¹ and Radiacwash.²

NOTE

IsoClean can cause fading of colored anodized surfaces. Use it only when necessary and remove it promptly from surfaces.

While Beckman Coulter has tested these methods and found that they do not damage components, no guarantee of decontamination is expressed or implied. Consult your laboratory safety officer regarding the proper decontamination methods to use.



If the rotor or other components are contaminated with toxic or pathogenic materials, follow appropriate decontamination procedures as outlined by your laboratory safety officer.

¹ In U.S., contact Nuclear Associates (New York); in Eastern Europe and Commonwealth States, contact Victoreen GmbH (Munich); in South Pacific, contact Gammasonics Pty. Ltd. (Australia); in Japan, contact Toyo Medic Co. Ltd. (Tokyo).

² In U.S., contact Biodex Medical Systems (Shirley, New York); internationally, contact the U.S. office to find the dealer closest to you.

STERILIZATION AND DISINFECTION

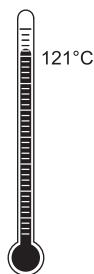

- The rotor and all rotor components can be autoclaved at 121°C for up to an hour. Remove the lid from the rotor and place the rotor, lid, and spacers in the autoclave upside down.
- Ethanol (70%)³ or hydrogen peroxide (6%) may be used on all rotor components, including those made of plastic. Bleach (sodium hypochlorite) may be used, but may cause discoloration of anodized surfaces. Use the minimum immersion time for each solution, per laboratory standards.

While Beckman Coulter has tested these methods and found that they do not damage the rotor or components, no guarantee of sterility or disinfection is expressed or implied. When sterilization or disinfection is a concern, consult your laboratory safety officer regarding proper methods to use.

Refer to publication IN-192, included in each box of tubes or bottles, for tube and bottle sterilization and disinfection procedures. *Quick-Seal and thinwall open-top tubes are disposable and should be discarded after a single use.*

STORAGE

When the rotor is not in use, store it in a dry environment (not in the instrument) with the lid removed to allow air circulation so moisture will not collect in the tube cavities.

³ Flammability hazard. Do not use in or near operating centrifuges.

RETURNING A ROTOR

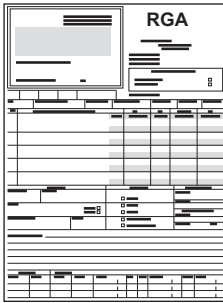

Before returning a rotor or accessory for any reason, prior permission (a Returned Goods Authorization form) must be obtained from Beckman Coulter, Inc. This RGA form may be obtained from your local Beckman Coulter sales office, and should contain the following information:

- serial number
- history of use (approximate frequency of use),
- reason for the return,
- original purchase order number, billing number, and shipping number, if possible,
- name and phone number of the person to be notified upon receipt of the rotor or accessory at the factory, and,
- name and phone number of the person to be notified about repair costs, etc.

To protect our personnel, it is the customer's responsibility to ensure that all parts are free from pathogens and/or radioactivity. Sterilization and decontamination must be done before returning the parts. Smaller items (such as tubes, bottles, etc.) should be enclosed in a sealed plastic bag.

*All parts must be accompanied by a note, plainly visible on the outside of the box or bag, stating that they are safe to handle and that they are not contaminated with pathogens or radioactivity. **Failure to attach this notification will result in return or disposal of the items without review of the reported problem.***

Use the address label printed on the RGA form when mailing the rotor and/or accessories.

Customers located outside the United States should contact their local Beckman Coulter office.

SUPPLY LIST

NOTE

Publications referenced in this manual can be obtained by calling Beckman Coulter at 1-800-742-2345 in the United States, or by contacting your local Beckman Coulter office.

See the *Beckman Coulter Ultracentrifuge Rotors, Tubes, & Accessories Catalog* (BR-8101, available at www.beckmancoulter.com) for detailed information on ordering parts and supplies or contact Beckman Coulter sales (1-800-742-2345 in the United States; worldwide offices are listed on the back cover of this manual). For your convenience, a partial list is given below.

REPLACEMENT ROTOR PARTS

Type 90 Ti rotor assembly	355530
Rotor lid.	355528
Rotor handle	355529
O-ring (large).	876089
O-ring (small)	839347
Overspeed disk (90 000 rpm)	355539

OTHER

Tubes, bottles, and accessories	see Table 1
OptiSeal tube rack assembly	361642
Quick-Seal Cordless Tube Topper kit, 60 Hz	358312
Quick-Seal Cordless Tube Topper kit, 50 Hz (Europe)	358313
Quick-Seal Cordless Tube Topper kit, 50 Hz (Great Britain).	358314
Quick-Seal Cordless Tube Topper kit, 50 Hz (Australia)	358315
Quick-Seal Cordless Tube Topper kit, 50 Hz (Canada)	367803
Tube Topper rack	348123
Tool kit for aluminum caps	331202
includes:	
Torque wrench.	858121
Socket adapter	858122
Socket for 11-mm hex nuts	870432
Tube removal tool	301875
Hex driver (for 11-mm cap nuts on stainless steel tubes)	841883

Handle tool	356959
Floating spacer removal tool	338765
Tube-cap vise	305075
Tube removal tool (Quick-Seal and OptiSeal tubes).	361668
Spinkote lubricant (2 oz).	306812
Silicone vacuum grease (1 oz)	335148
Rotor Cleaning Kit	339558
Beckman Solution 555 (1 qt)	339555
Rotor cleaning brush	339379
Centering tool (for replacing overspeed disk).	331325

TRADEMARKS

Beckman Coulter, Quick-Seal and the stylized logo are trademarks of Beckman Coulter, Inc. and are registered in the USPTO. All other trademarks, service marks, products, or services are trademarks or registered trademarks of their respective holders.

ULTRACENTRIFUGE ROTOR WARRANTY

All Beckman Coulter ultracentrifuge Fixed Angle, Vertical Tube, Near Vertical Tube, Swinging Bucket, and Airfuge rotors are warranted against defects in materials or workmanship for the time periods indicated below, subject to the Warranty Conditions stated below.

Preparative Ultracentrifuge Rotors 5 years — No Proration

Analytical Ultracentrifuge Rotors 5 years — No Proration

ML and TL Series Ultracentrifuge Rotors 5 years — No Proration

Airfuge Ultracentrifuge Rotors 1 year — No Proration

For Zonal, Continuous Flow, Component Test, and Rock Core ultracentrifuge rotors, see separate warranty.

Warranty Conditions (as applicable)

- 1) This warranty is valid for the time periods indicated above from the date of shipment to the original Buyer by Beckman Coulter or an authorized Beckman Coulter representative.
- 2) This warranty extends only to the original Buyer and may not be assigned or extended to a third person without written consent of Beckman Coulter.
- 3) This warranty covers the Beckman Coulter Centrifuge Systems only (including but not limited to the centrifuge, rotor, and accessories) and Beckman Coulter shall not be liable for damage to or loss of the user's sample, non-Beckman Coulter tubes, adapters, or other rotor contents.
- 4) This warranty is void if the Beckman Coulter Centrifuge System is determined by Beckman Coulter to have been operated or maintained in a manner contrary to the instructions in the operator's manual(s) for the Beckman Coulter Centrifuge System components in use. This includes but is not limited to operator misuse, abuse, or negligence regarding indicated maintenance procedures, centrifuge and rotor classification requirements, proper speed reduction for the high density of certain fluids, tubes, and tube caps, speed reduction for precipitating gradient materials, and speed reduction for high-temperature operation.
- 5) Rotor bucket sets purchased concurrently with or subsequent to the purchase of a Swinging Bucket Rotor are warranted only for a term co-extensive with that of the rotor for which the bucket sets are purchased.
- 6) This warranty does not cover the failure of a Beckman Coulter rotor in a centrifuge not of Beckman Coulter manufacture, or if the rotor is used in a Beckman Coulter centrifuge that has been modified without the written permission of Beckman Coulter, or is used with carriers, buckets, belts, or other devices not of Beckman Coulter manufacture.
- 7) Rotor parts subject to wear, including but not limited to rotor O-rings, VTi, NVT™, TLV, MLN, and TLN rotor tube cavity plugs and gaskets, tubing, tools, optical overspeed disks, bearings, seals, and lubrication are excluded from this warranty and should be frequently inspected and replaced if they become worn or damaged.
- 8) Keeping a rotor log is not mandatory, but may be desirable for maintenance of good laboratory practices.

Repair and Replacement Policies

- 1) If a Beckman Coulter rotor is determined by Beckman Coulter to be defective, Beckman Coulter will repair or replace it, subject to the Warranty Conditions. A replacement rotor will be warranted for the time remaining on the original rotor's warranty.
- 2) If a Beckman Coulter centrifuge is damaged due to a failure of a rotor covered by this warranty, Beckman Coulter will supply free of charge (i) all centrifuge parts required for repair (except the drive unit, which will be replaced at the then current price less a credit determined by the total number of revolutions or years completed, provided that such a unit was manufactured or rebuilt by Beckman Coulter), and (ii) if the centrifuge is currently covered by a Beckman Coulter warranty or Full Service Agreement, all labor necessary for repair of the centrifuge.
- 3) If a Beckman Coulter rotor covered by this warranty is damaged due to a malfunction of a Beckman Coulter ultracentrifuge covered by an Ultracentrifuge System Service Agreement, Beckman Coulter will repair or replace the rotor free of charge.
- 4) If a Beckman Coulter rotor covered by this warranty is damaged due to a failure of a Beckman Coulter tube, bottle, tube cap, spacer, or adapter, covered under the Conditions of this Warranty, Beckman Coulter will repair or replace the rotor and repair the instrument as per the conditions in policy point (2) above, and the replacement policy.
- 5) Damage to a Beckman Coulter rotor or instrument due to the failure or malfunction of a non-Beckman Coulter tube, bottle, tube cap, spacer, or adapter is not covered under this warranty, although Beckman Coulter will assist in seeking compensation under the manufacturer's warranty.

Disclaimer

IT IS EXPRESSLY AGREED THAT THE ABOVE WARRANTY SHALL BE IN LIEU OF ALL WARRANTIES OF FITNESS AND OF THE WARRANTY OF MERCHANTABILITY AND BECKMAN COULTER, INC. SHALL HAVE NO LIABILITY FOR SPECIAL OR CONSEQUENTIAL DAMAGES OF ANY KIND WHATSOEVER ARISING OUT OF THE MANUFACTURE, USE, SALE, HANDLING, REPAIR, MAINTENANCE, OR REPLACEMENT OF THE PRODUCT.

Factory Rotor Inspection Service

Beckman Coulter, Inc., will provide free mechanical and metallurgical inspection in Indianapolis, Indiana, USA, of any Beckman Coulter rotor at the request of the user. (Shipping charges to Beckman Coulter are the responsibility of the user.) Rotors will be inspected in the user's laboratory if the centrifuge in which they are used is covered by an appropriate Beckman Coulter Service Agreement. Contact your local Beckman Coulter office for details of service coverage or cost.

Before shipping, contact the nearest Beckman Coulter Sales and Service office and request a Returned Goods Authorization (RGA) form and packaging instructions. Please include the complete rotor assembly, with buckets, lid, handle, tube cavity caps, etc. A SIGNED STATEMENT THAT THE ROTOR AND ACCESSORIES ARE NON-RADIOACTIVE, NON-PATHOGENIC, NON-TOXIC, AND OTHERWISE SAFE TO SHIP AND HANDLE IS REQUIRED.



Beckman Coulter, Inc. • 250 S. Kraemer Blvd. • Brea, California 92821 U.S.A.
Sales and Service: 1-800-742-2345 • Internet: www.beckmancoulter.com • Printed in U.S.A.

©2014 Beckman Coulter, Inc.
All rights reserved